

Review

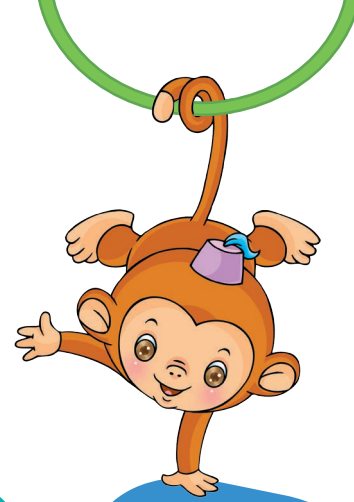

Trace, color and write

Name: _____

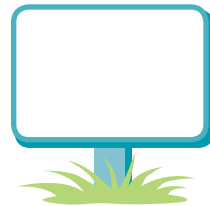
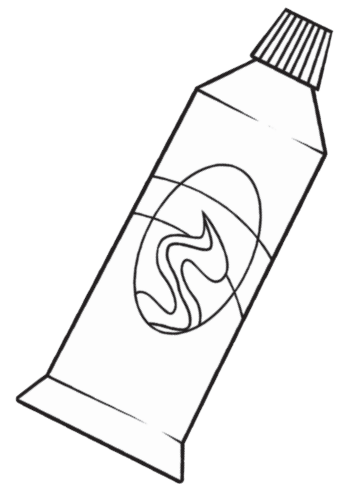
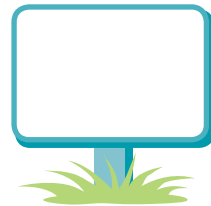
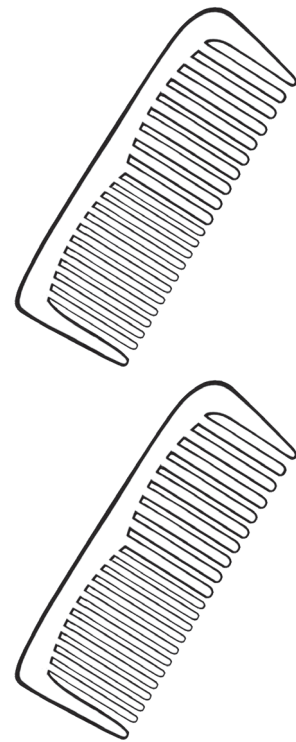
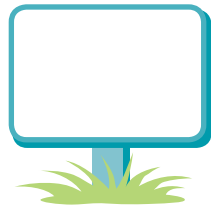
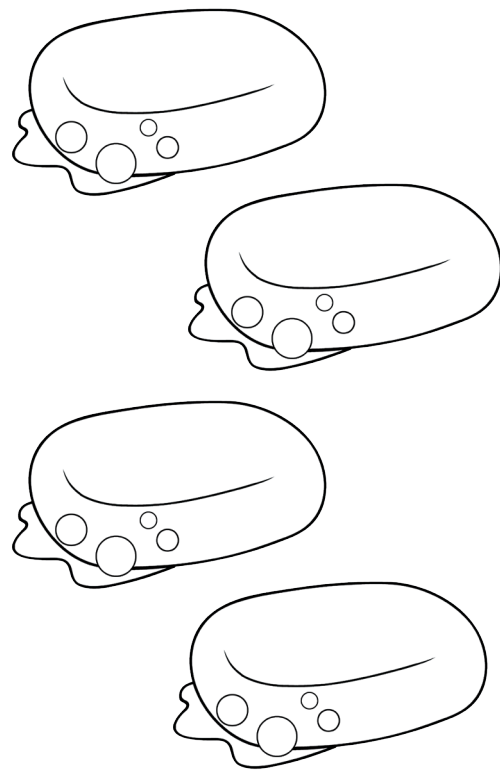
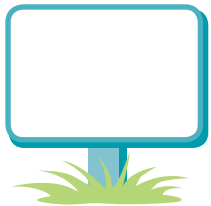
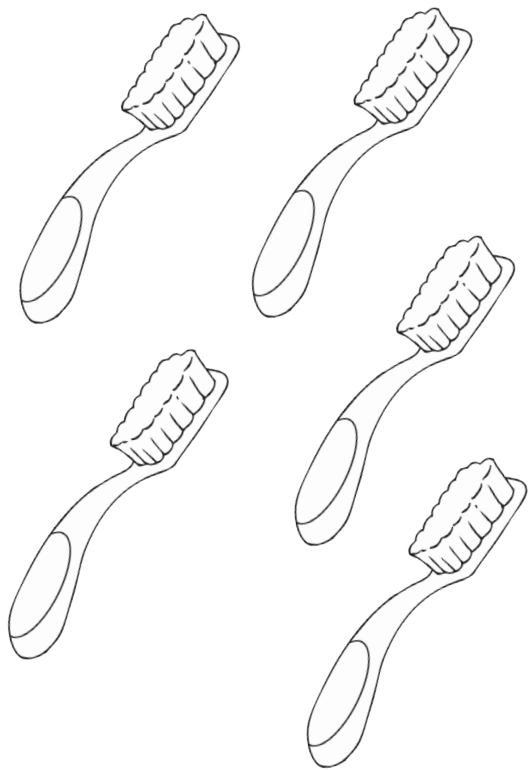
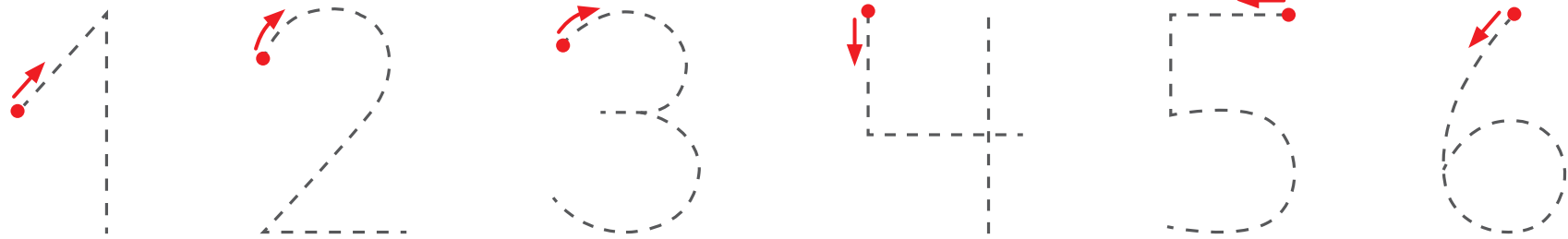

Look and trace

Name: _____



• Look and draw

Name: _____

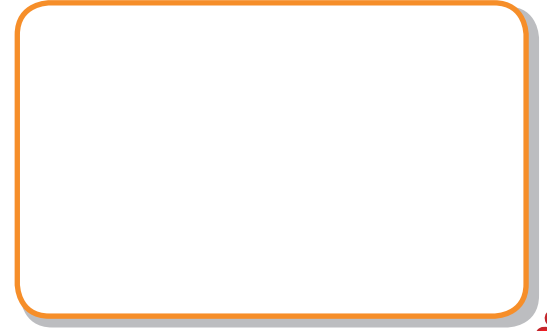
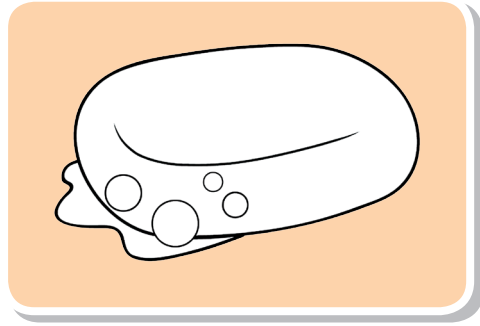
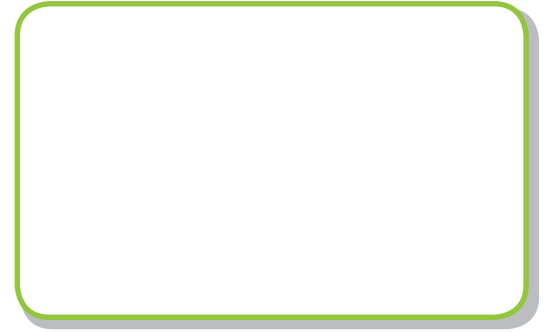
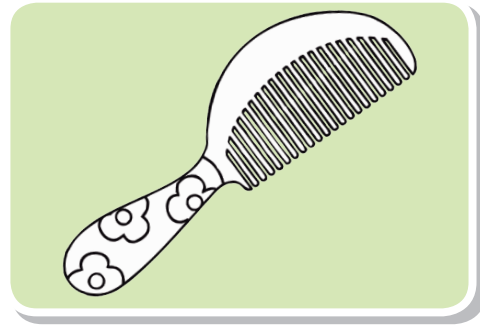
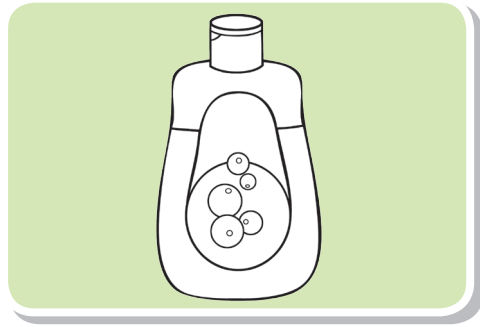
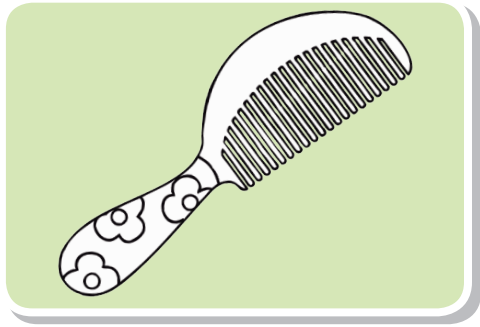
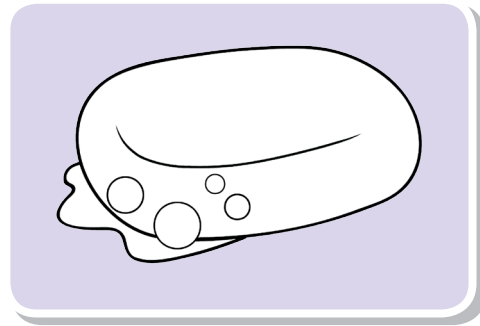
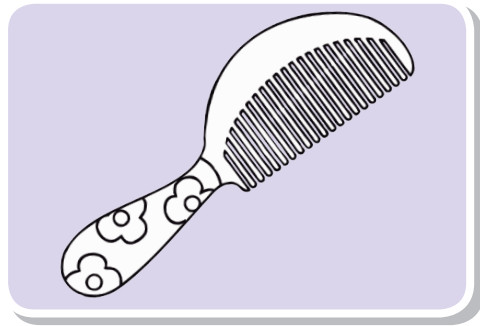
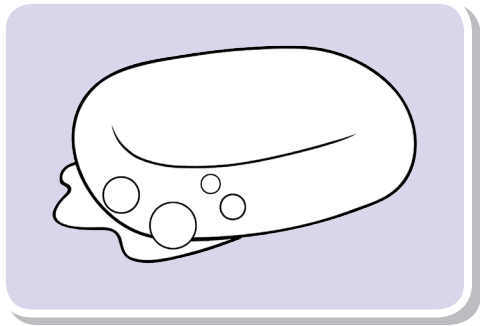

Color, cut and do the puzzle

Name: _____

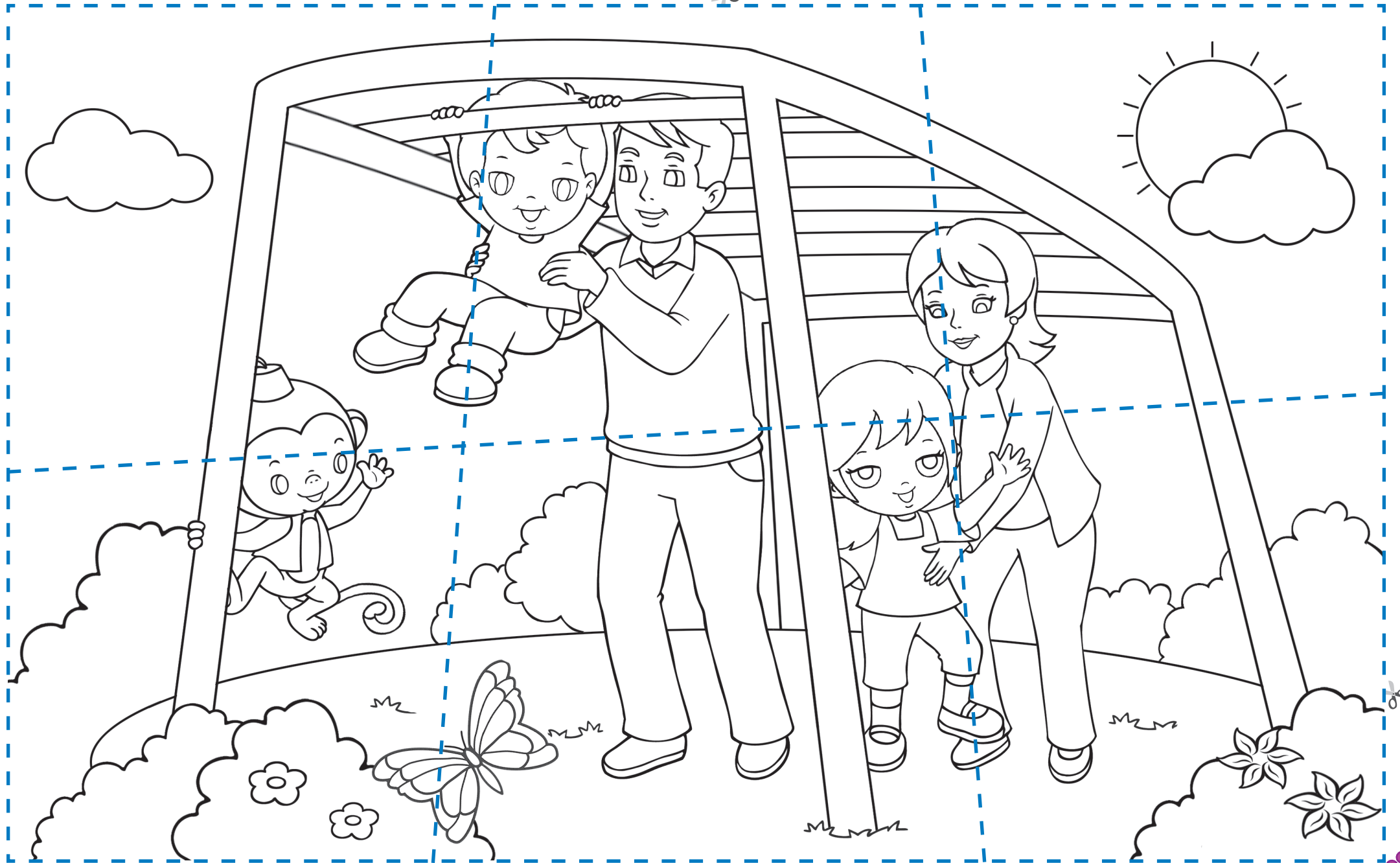

Trace and color

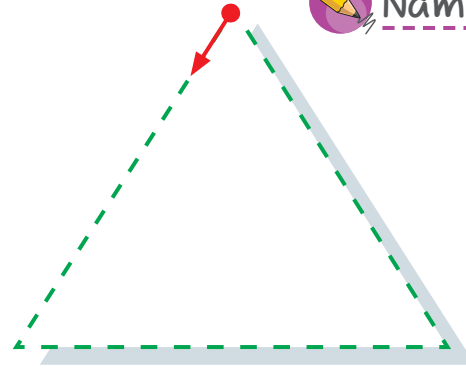
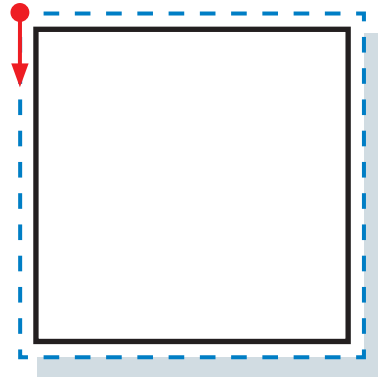

Name: _____

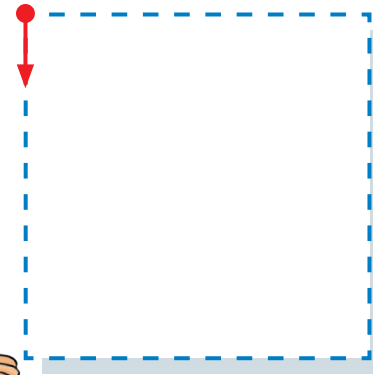
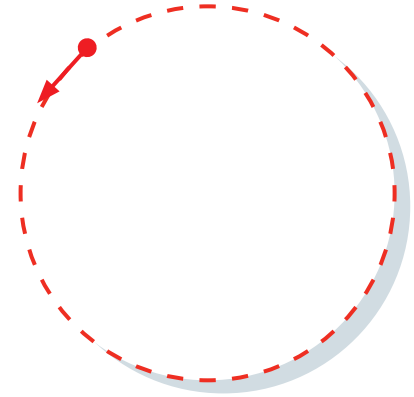
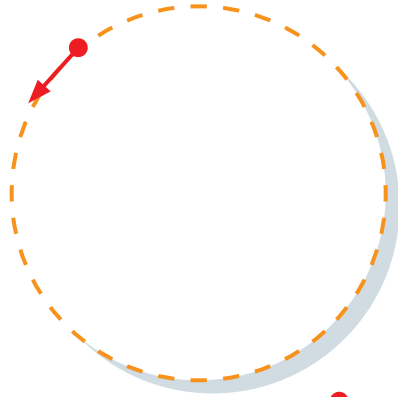

Trace and color

Name: _____

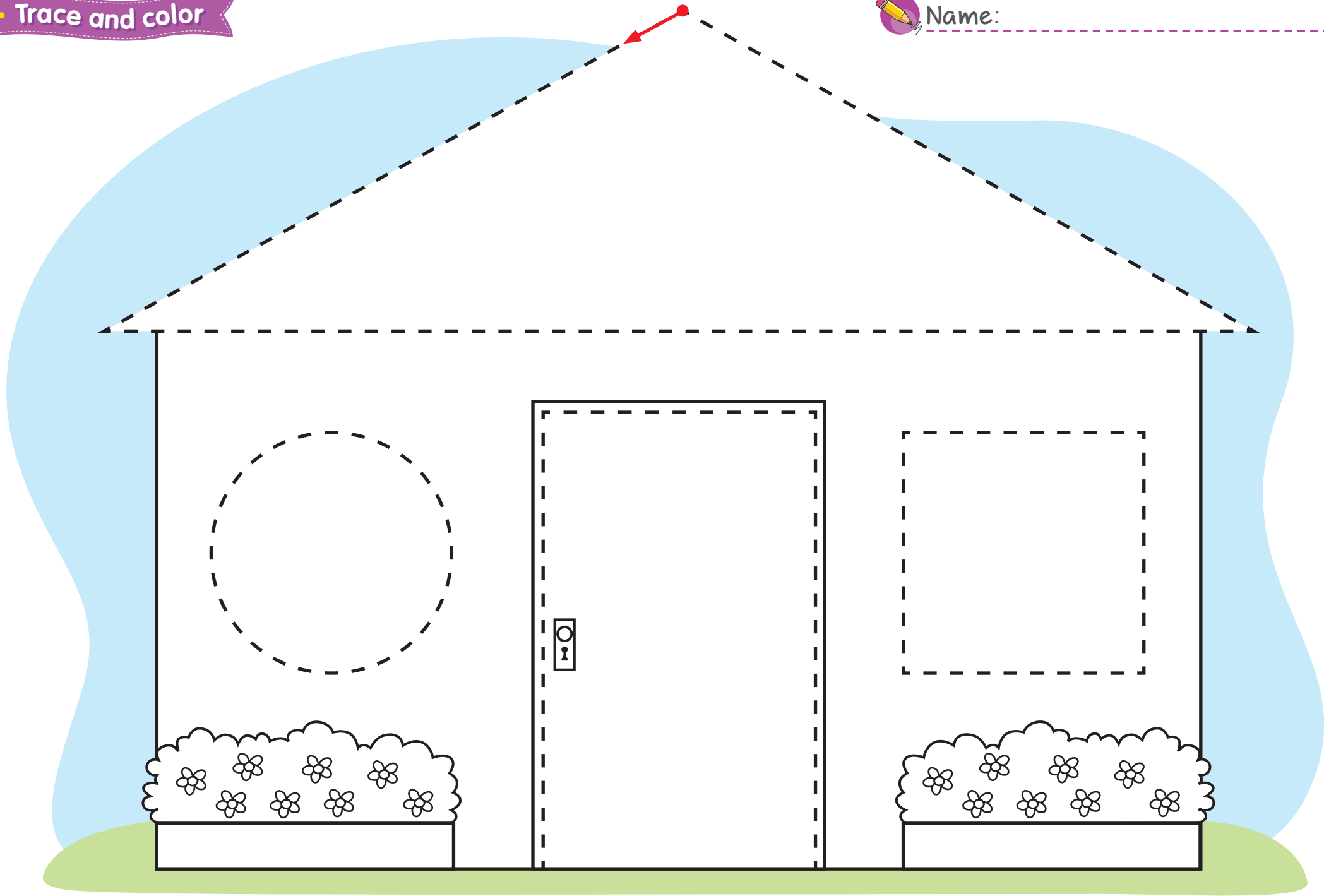

Follow the sequence

Name: _____

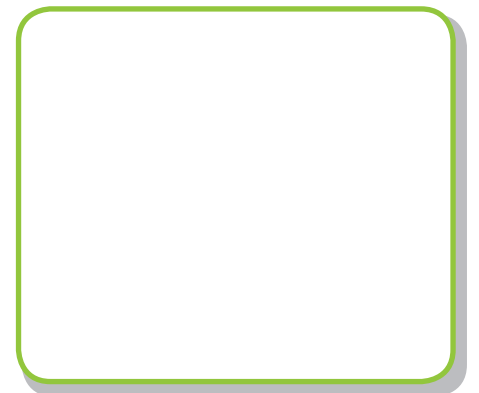
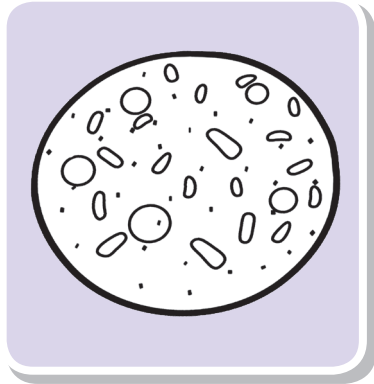
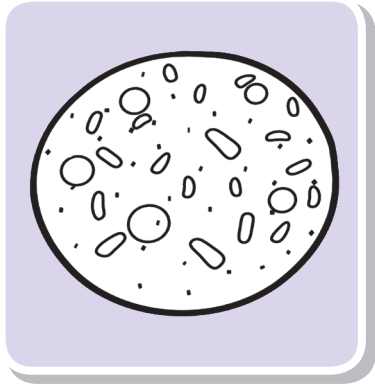

• Paste less on the left and more on the right

• Less •

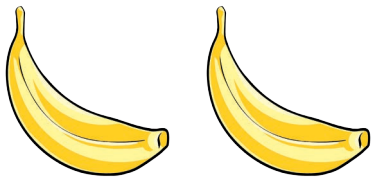

Empty space for pasting items, bounded by a purple line.

Empty space for pasting items, bounded by a green line.

Empty space for pasting items, bounded by an orange line.

Empty space for pasting items, bounded by a blue line.

 Name: _____

• More •



Empty space for pasting items, bounded by a purple line.

Empty space for pasting items, bounded by a green line.

Empty space for pasting items, bounded by an orange line.

Empty space for pasting items, bounded by a blue line.

Color where are more

Name: _____

1

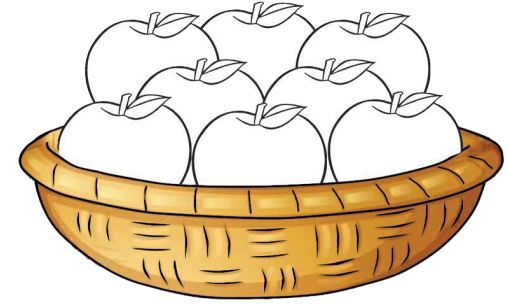
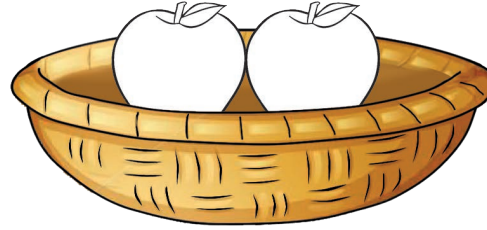
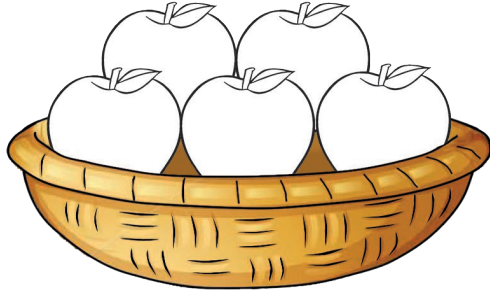

2



3



4

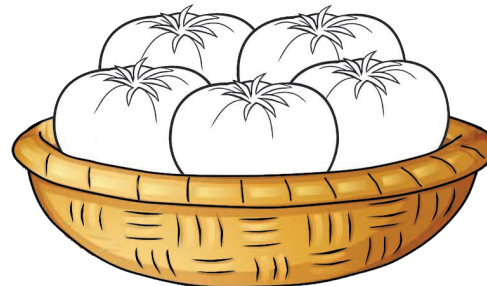
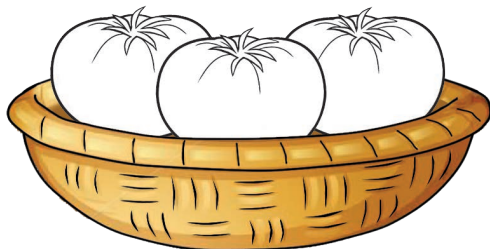

Match and color

Name: _____

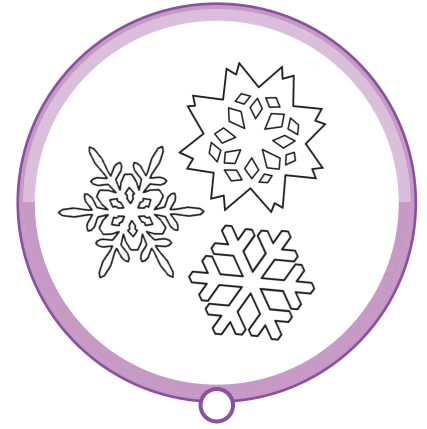
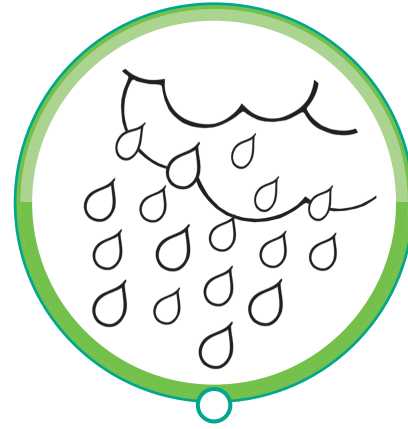
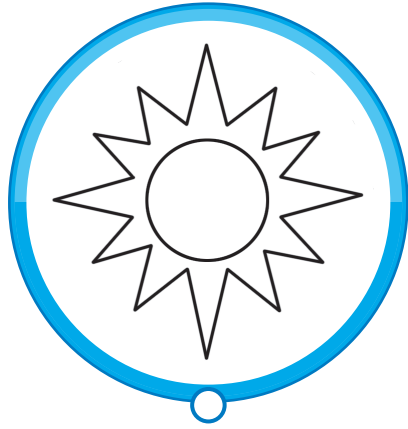

Look, match and color

Name: _____

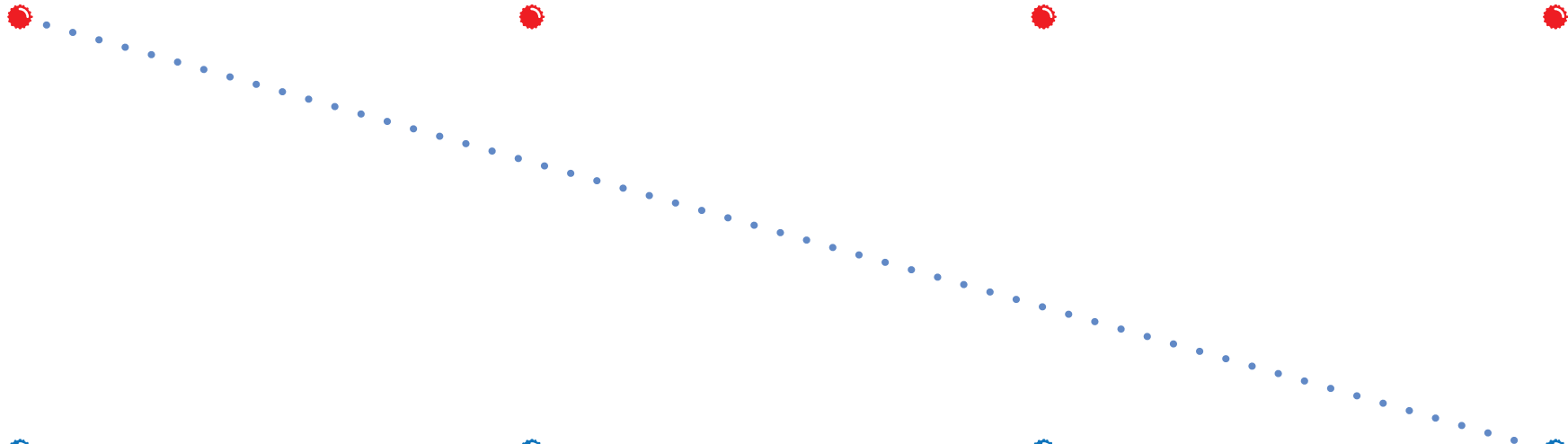
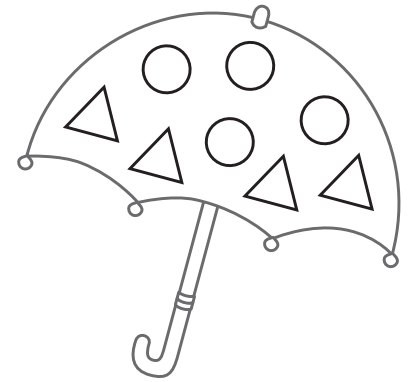
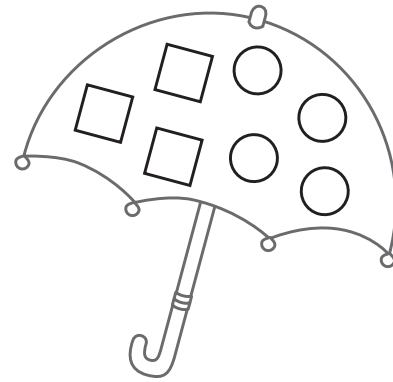

• Look, cut and glue

Name: _____

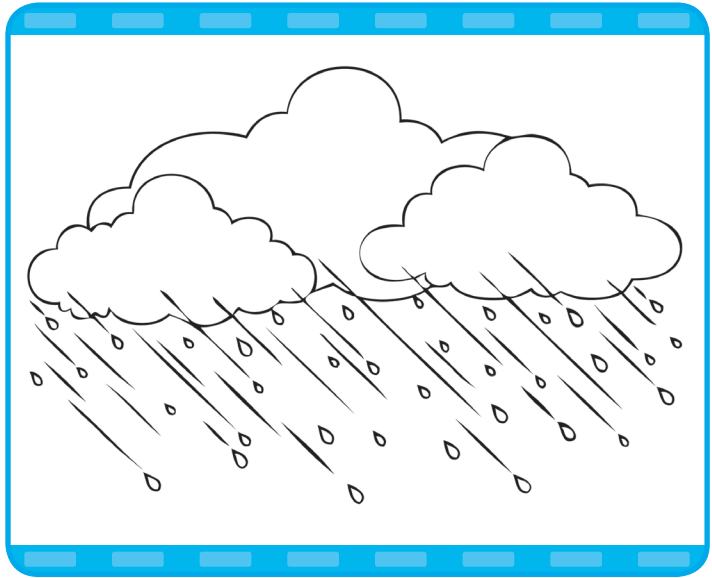
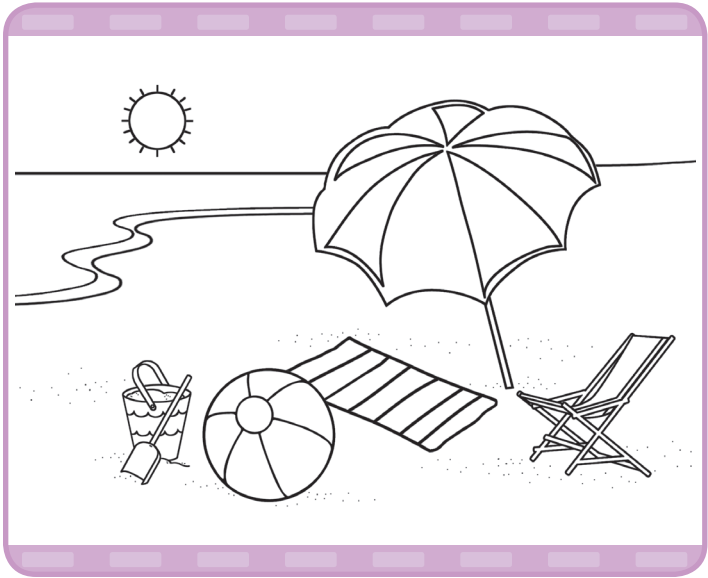

Color, cut and do the puzzle

Name: _____

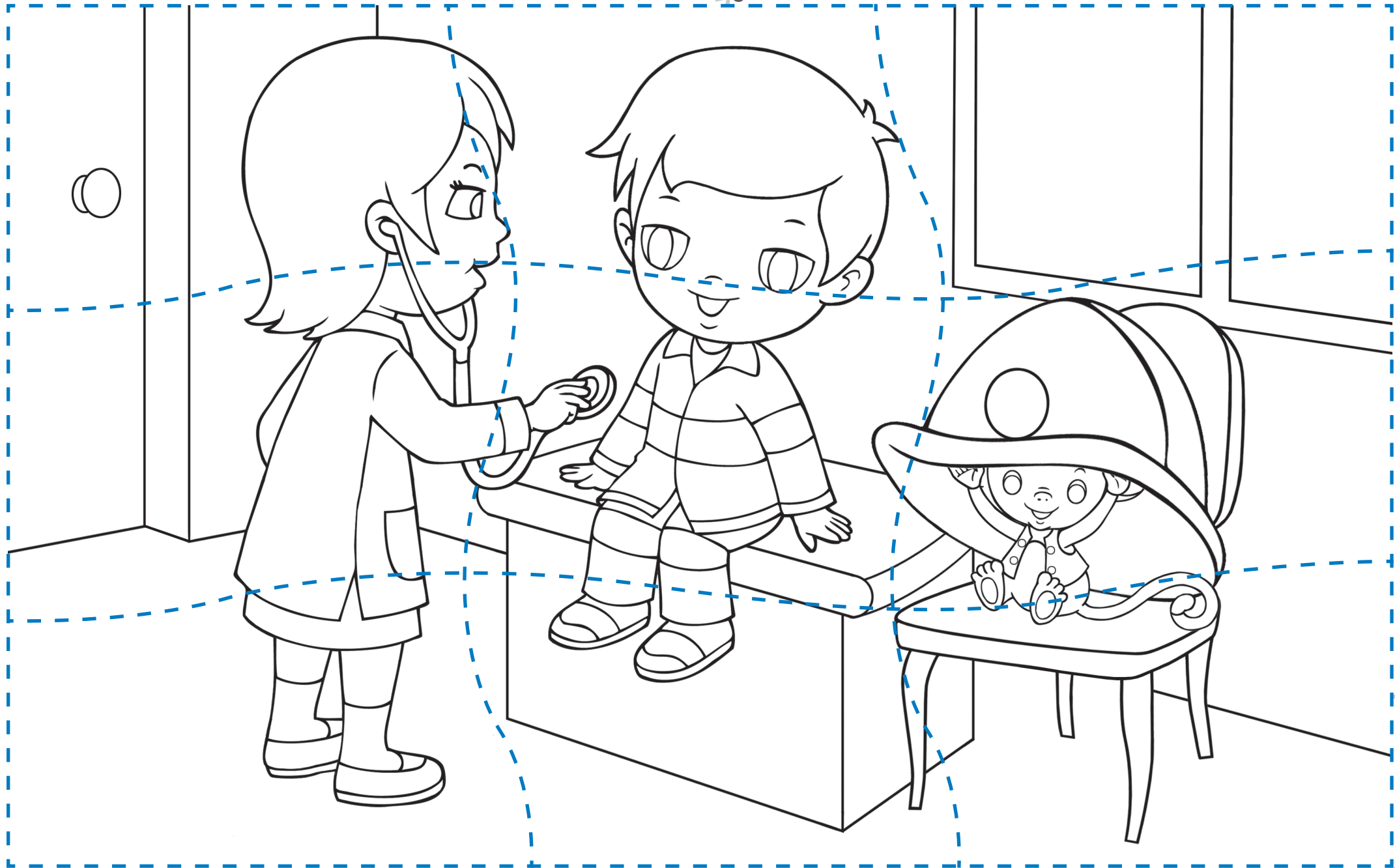

Cut and assemble

Name: _____



Fold

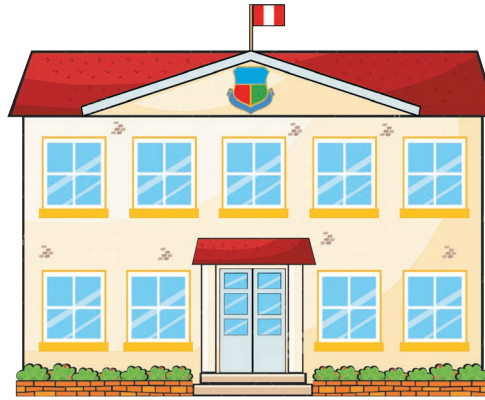

Fold



Fold



Fold



Fold



Fold



Connect the dots in number order

Name: _____

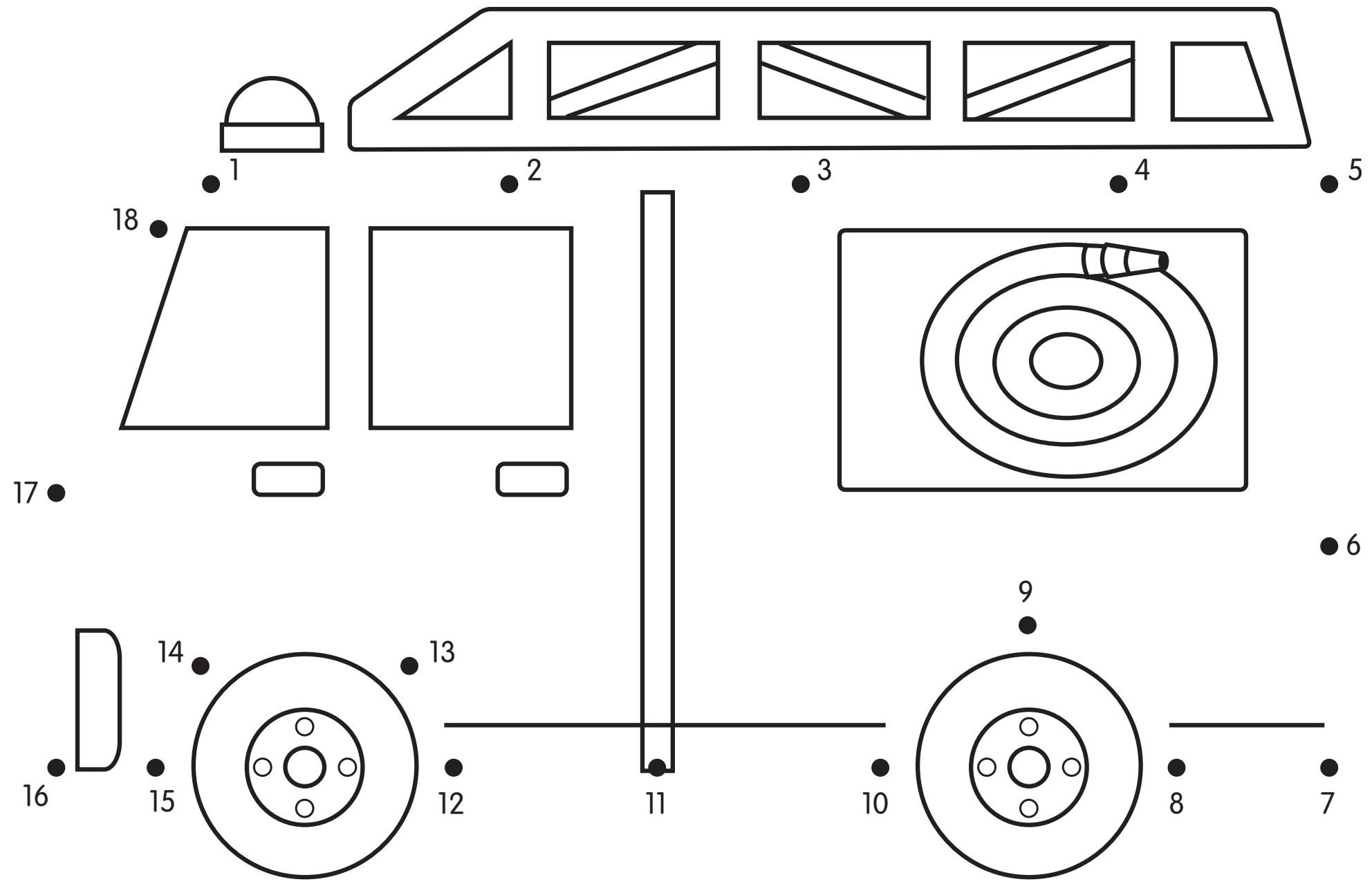

Find and color

Name: _____

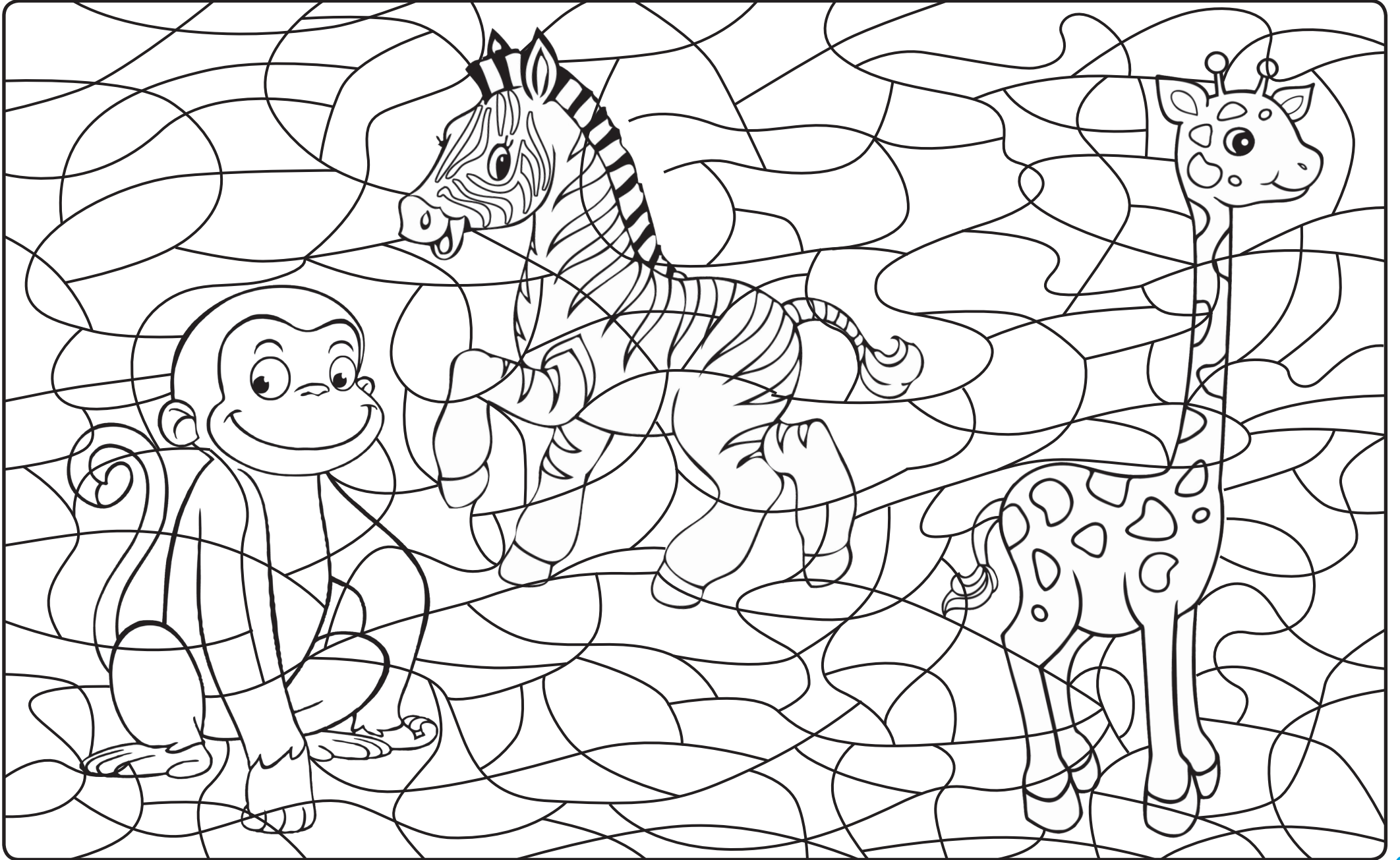

Follow the path and trace

Name: _____

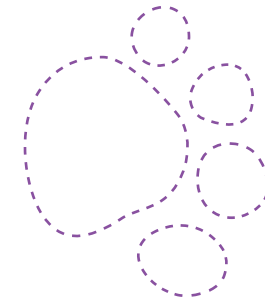
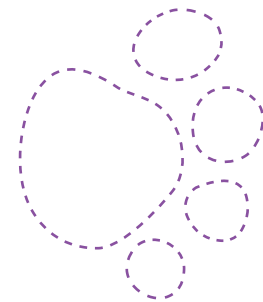
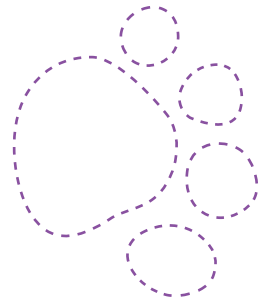
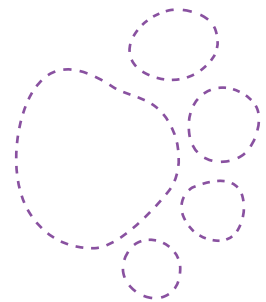
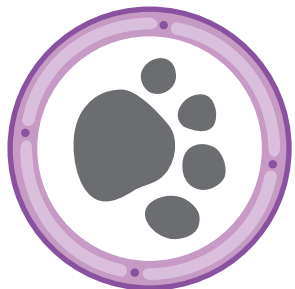
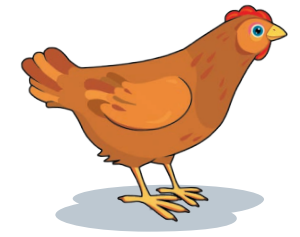
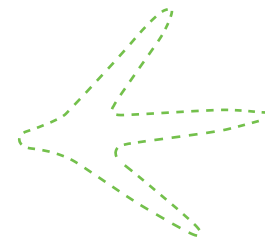
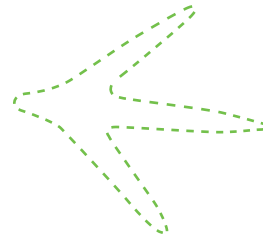
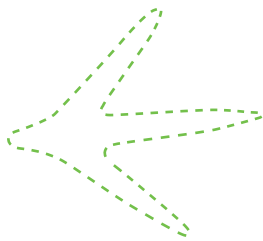
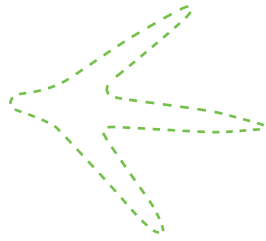
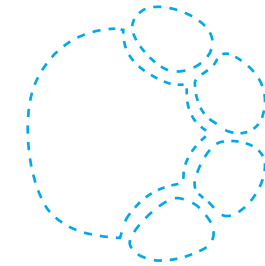
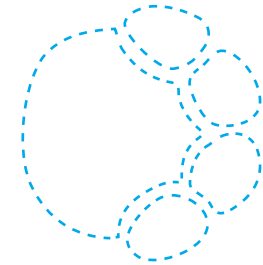
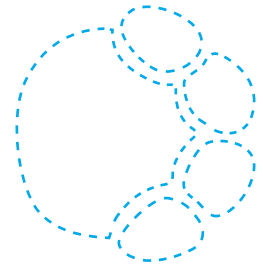
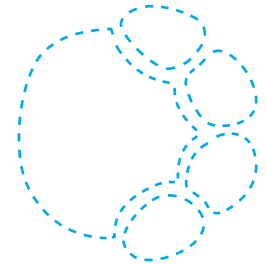
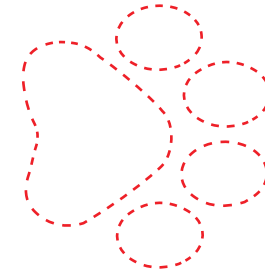
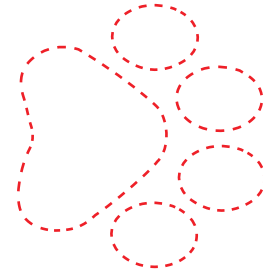
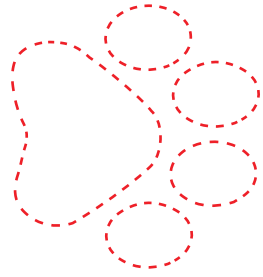
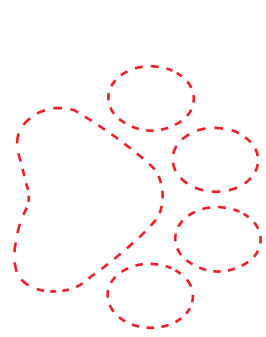

• Draw and color your favorite animal

Name: _____

My favorite animal

